

ZAHNMEDIZIN DENTISTRY

**2025
2026**

**INNOVATION UND
PRÄZISION
SIND UNSER ANTRIEB.**

***INNOVATION AND
PRECISION ARE OUR
MOTIVATION.***



DFS

Dental Future Systems

D I A M O N

www.dfs-diamon.de

FG Piranhas in 3-Lagen Diamantierung

FG piranhas with three-layer diamond technology

ISO Nr.: 806 314 F 504 superfein / superfine
 806 314 F 514 fein / fine
 806 314 F 524 mittel / medium
 806 314 F 534 grob / coarse

Drehzahl / speed
 30' - 300000 Upm / rpm

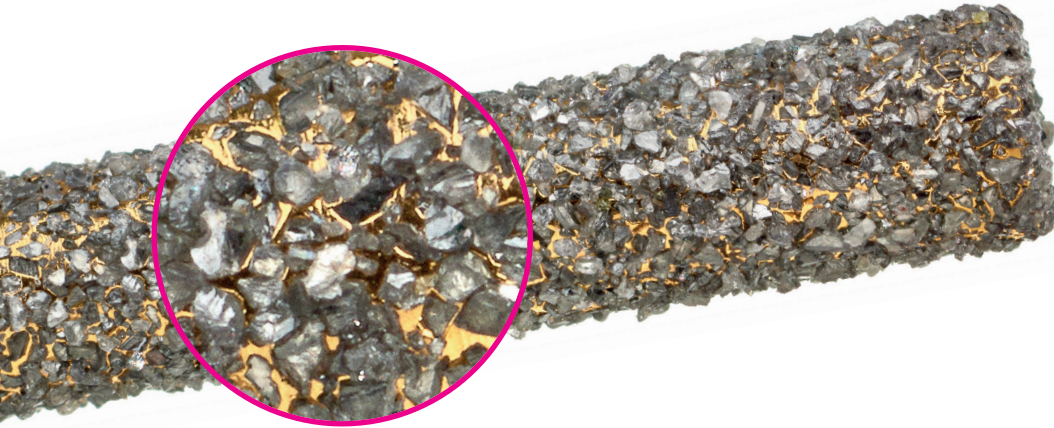
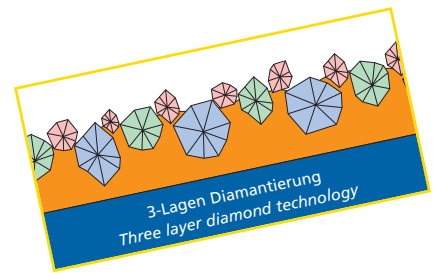

 801	F:	001	001	001	001	001	001	001	001
	d:	008	010	012	014	016	018	021	027
	KL/hl:	0,7	0,9	1,1	1,3	1,5	1,8	2,1	2,7
	P:	8	8	8	8	8	8	9	9

 805	F:	010	010
	d:	012	014
	KL/hl:	1,5	1,5
	P:	8	8

539008S

539178S
539175S

539228S
539225S

539918S
539915S

539928S
539925S

539938S
539935S

539218S
539215S

539278S

539428S

539438S

 811	F:	039
	d:	033
	KL/hl:	4,5
	P:	9

 909	F:	068
	d:	037
	KL/hl:	1
	P:	9

 835	F:	109
	d:	010
	KL/hl:	4
	P:	8

 837	F:	111
	d:	016
	KL/hl:	8
	P:	8

539308S

539688S

539998S

539868

Piranhas sind zu 2 Stück verpackt.
 F = ISO-Figur-Nr. · KL = Kopflänge in mm
 d = Durchmesser in 1/10 mm · P = Preiskategorie

Piranhas are packed as 2 pieces.
 F = ISO-Shape-No. · hl = head length in mm
 d = diameter in 1/10 mm · P = price category



FG Piranhas in 3-Lagen Diamantierung

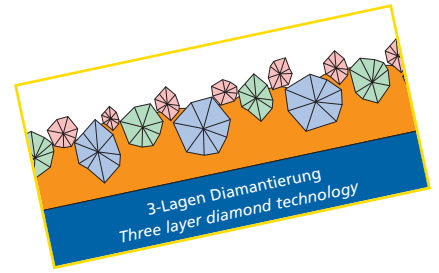

FG piranhas with three-layer diamond technology

ISO Nr.: 806 314 F 504 superfein / superfine
 806 314 F 514 fein / fine
 806 314 F 524 mittel / medium
 806 314 F 534 grob / coarse



Drehzahl / speed
 30' - 300000 Upm / rpm







		F : 140	140
		d : 012	014
		KL/hl : 6,5	6
		P : 8	8

		F : 141	141	141	141
		d : 012	014	016	018
		KL/hl : 8,5	8,5	8,5	8,5
		P : 8	8	8	8



539018
539015
539028
539025
539034
539036
539038
539035
539046
539048
539045
539316
539315
539318



		F : 156	
		d : 012	
		KL/hl : 5	
		P : 8	



		F : 158	158	158
		d : 010	012	014
		KL/hl : 8	8	8
		P : 8	8	8



		F : 161	
		d : 012	
		KL/hl : 6	
		P : 8	

539078
539075
5390645
5390545
5390685
5390585
5390555
539086
539088
539085
539765
539785
539755

		F : 165	
		d : 014	
		KL/hl : 8	
		P : 8	

		F : 166	166
		d : 010	018
		KL/hl : 10	10
		P : 8	8

		F : 167	
		d : 010	
		KL/hl : 11	
		P : 8	

		F : 173	
		d : 014	
		KL/hl : 10	
		P : 8	

5390965
5390985
5390955
5397965
5397865
5397955
5397855
539346
5392555

Piranhas sind zu 2 Stück verpackt.
 F = ISO-Figur-Nr. · KL = Kopflänge in mm
 d = Durchmesser in 1/10 mm · P = Preiskategorie

Piranhas are packed as 2 pieces.
 F = ISO-Shape-No. · hl = head length in mm
 d = diameter in 1/10 mm · P = price category



FG Piranhas in 3-Lagen Diamantierung

FG piranhas with three-layer diamond technology



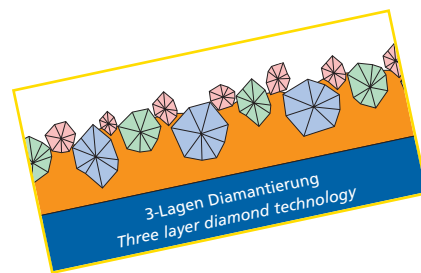

ISO Nr.: 806 314 F 504 superfein / superfine
 806 314 F 514 fein / fine
 806 314 F 524 mittel / medium
 806 314 F 534 grob / coarse

Drehzahl / speed
 30' - 300000 Upm / rpm









	F : d : KL/hl : P :		
		197	197
		012	014
		6	6
8	8	8	8



539158S
 539168S
 539244S

	F : d : KL/hl : P :			
		198	198	198
		016	018	021
		8	8	8
8	8	8	9	



539584S
 539586S
 539588S
 539585S
 539594S
 539596S
 539598S
 539595S
 539606S

	F : d : KL/hl : P :							
		199	199	199	199	199	199	199
		010	012	014	016	018	018	018
		10	10	10	10	10	10	10
8	8	8	8	8	8	8		



539104S
 539108S
 539105S
 539116
 539118
 539115
 539128
 539126
 539125
 539144S
 539146S
 539148S
 539145S
 539176

	F : d : KL/hl : P :		
		225	225
		018	018
		5	5
8	8		



539136
 539138
 539135

	F : d : KL/hl : P :		
		234	234
		014	016
		5	5
8	8		





539188
 539185
 539195

	F : d : KL/hl : P :		
		238	238
		012	014
		3	3
8	8		

539208S
 539205S
 539288S
 539285S

	F : d : KL/hl : P :	
		249
		012
		8
8		

539236
 539238
 539235

	F : d : KL/hl : P :			
		250	250	250
		012	014	016
		10	10	10
8	8	8		

539264S
 539266
 539268
 539265
 539276
 539278
 539275
 539286
 539288
 539285

Piranhas sind zu 2 Stück verpackt.
 F = ISO-Figur-Nr. · KL = Kopflänge in mm
 d = Durchmesser in 1/10 mm · P = Preiskategorie

Piranhas are packed as 2 pieces.
 F = ISO-Shape-No. · hl = head length in mm
 d = diameter in 1/10 mm · P = price category



FG Piranhas in 3-Lagen Diamantierung

FG piranhas with three-layer diamond technology

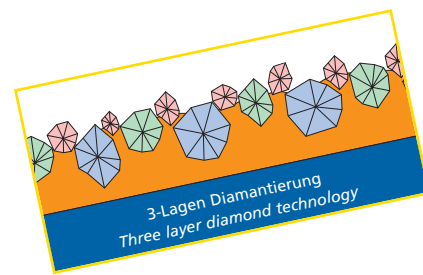

ISO Nr.: 806 314 F 504 superfein / superfine
 806 314 F 514 fein / fine
 806 314 F 524 mittel / medium
 806 314 F 534 grob / coarse

Drehzahl / speed
 30' - 30000 Upm / rpm





		F : 251
		d : 016
		KL/hl : 11,6
		P : 8



539296
 539298
 539295

		F : 257	257
		d : 018	023
		KL/hl : 4,5	5
		P : 8	9



539326
 539328
 539325
 539354
 539356
 539358
 539355

		F : 269
		d : 016
		KL/hl : 8
		P : 8



539494S
 539498S

		F : 277	277
		d : 023	023
		KL/hl : 4,5	5,5
		P : 9	9



539416
 539418
 539415
 539166
 539165

		F : 289	289	289
		d : 010	012	014
		KL/hl : 8	7,5	8
		P : 8	8	8



539516
 539518
 539515
 539526
 539528
 539525
 539536
 539538
 539535

		F : 290	290	290
		d : 012	014	016
		KL/hl : 10	10	10
		P : 8	8	8

539616
 539618
 539615
 539626
 539628
 539625
 539636S
 539638S
 539635S

		F : 297
		d : 012
		KL/hl : 6
		P : 8

539675

		F : 298	298	298	298	298
		d : 014	016	018	020	022
		KL/hl : 8	8	8	8	8
		P : 8	8	8	9	9

539726
 539728
 539725
 539738
 539735
 539746
 539745
 539755
 539765

Piranhas sind zu 2 Stück verpackt.
 F = ISO-Figur-Nr. · KL = Kopflänge in mm
 d = Durchmesser in 1/10 mm · P = Preiskategorie

Piranhas are packed as 2 pieces.
 F = ISO-Shape-No. · hl = head length in mm
 d = diameter in 1/10 mm · P = price category



FG Piranhas in 3-Lagen Diamantierung



FG piranhas with three-layer diamond technology

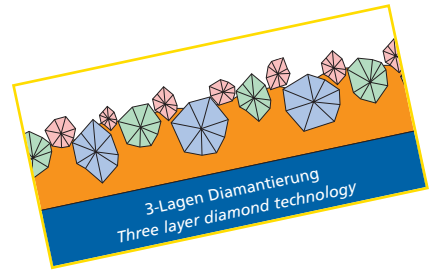

ISO Nr.: 806 314 F 504 superfein / superfine
 806 314 F 514 fein / fine
 806 314 F 524 mittel / medium
 806 314 F 534 grob / coarse



Drehzahl / speed
 30' - 300000 Upm / rpm



 879K	F :	299	299	299	299	299
	d :	012	014	016	018	021
	KL/hl :	10	10	10	10	10
	P :	8	8	8	8	9
						

 889	F :	540
	d :	009
	KL/hl :	3,5
	P :	8
		

 845KR	F :	544	544
	d :	018	025
	KL/hl :	4	4
	P :	8	9
			

 801L	F :	697	697	697
	d :	010	012	016
	KL/hl :	1,0	1,2	1,6
	P :	8	8	8
				



- 539816
- 539818
- 539815
- 539825
- 539836
- 539838
- 539835
- 539845
- 539855
- 539694S
- 539696S
- 539698S
- 539904
- 539954S
- 539908
- 539958S
- 539218
- 539228
- 539248

FG Piranhas lang

FG piranhas long

ISO Nr.: 806 315

Drehzahl / speed
 30' - 300000 Upm / rpm

 801	F :	001	001	001	001
	d :	012	014	016	018
	KL/hl :	1,1	1,3	1,5	1,8
	P :	10	10	10	10
					

- 539228SL
- 539918SL
- 539928SL
- 539938SL

Piranhas sind zu 2 Stück verpackt.
 F = ISO-Figur-Nr. · KL = Kopflänge in mm
 d = Durchmesser in 1/10 mm · P = Preiskategorie

Piranhas are packed as 2 pieces.
 F = ISO-Shape-No. · hl = head length in mm
 d = diameter in 1/10 mm · P = price category